

ENDURA PRO 32
32 LBS THRUST
12 VOLT 32 AMPS
30" SHAFT

for use with motors with serial numbers beginning MKAE
3-year warranty from the date of purchase

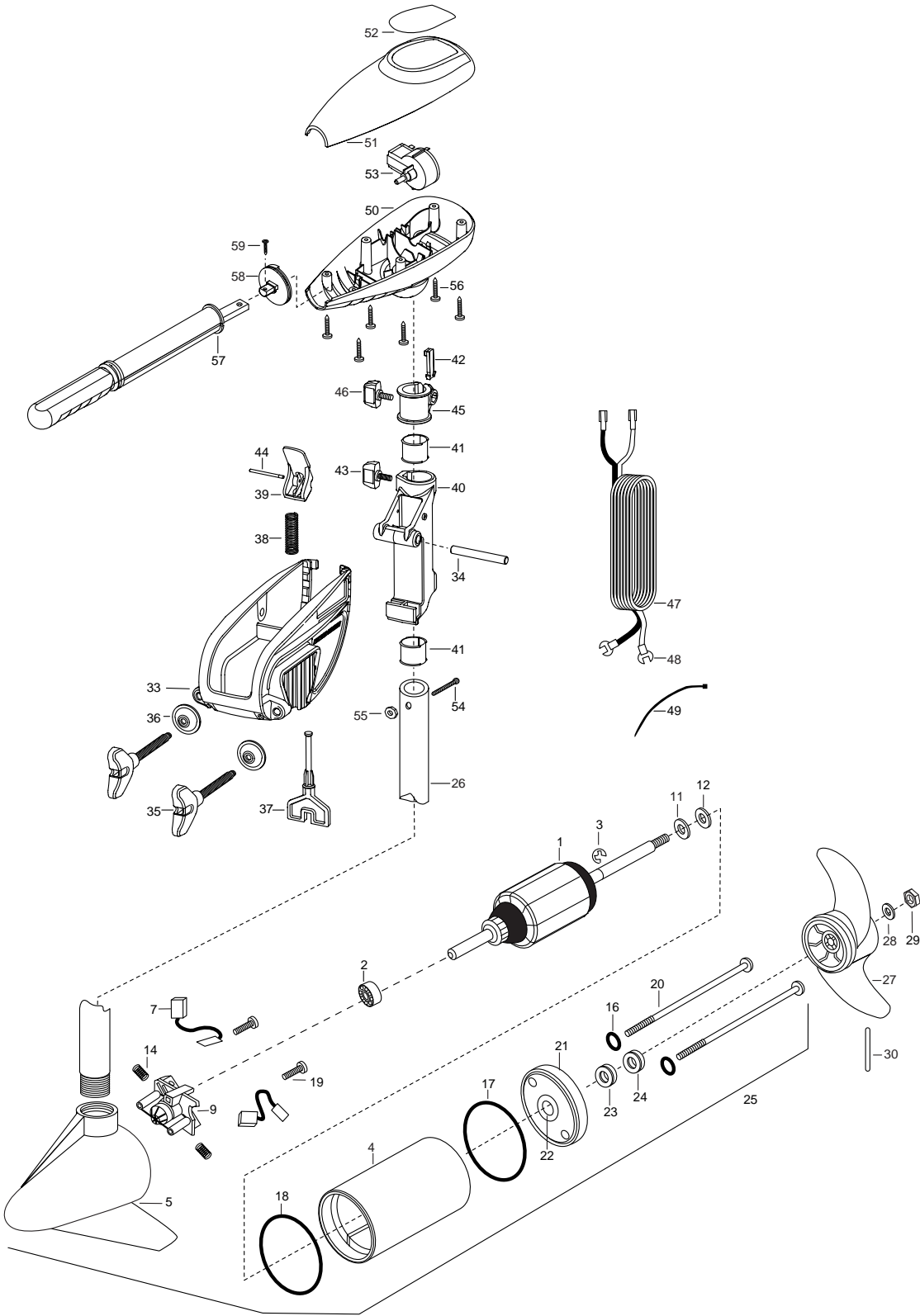

1	2-100-277	ARMATURE ASSEMBLY 12V 3.25	*36	2011710	WASHER-CLAMP SCREW [2.EA]
2	140-010	BALL BEARING	37	2063605	T-BAR, PLASTIC
3	788-015	RETAINING RING	38	2062706	SPRING- (T-BAR)
4	2-200-177	CENTER HOUSING ASSEMBLY 3.25 TXT	39	2067201	LEVER-TILT BLACK
5	2-300-142	BRUSH END HOUSING ASSEMBLY 3.25 SP CO	40	2061810	HINGE-PLASTIC
7	188-052	BRUSH ASSEMBLY	41	2037301	BUSHING-HINGE [2.EA]
9	737-030	BRUSH PLATE W/HOLDER 3.25 ASSEMBLY	42	2062800	TENSION BLOCK-SNAP IN
11	990-067	WASHER- STEEL	43	2011385	SCREW, TENSION/KNOB
12	990-070	WASHER- NYLATRON	44	2060515	PIN, TILT LEVER
14	975-032	SPRING- COMPRESSION	45	2061520	COLLAR-DEPTH ENDURA
16	701-007	**O-RING [2.EA]	46	2011365	SCREW-COLLAR/NEW KNOB
17	701-039	**O-RING MK406460	47	2020605	LEADWIRE- 14 GA SPADE TERM
18	701-041	**O-RING	48	2020703	TERMINAL-SPADE 14GA. [2.EA]
19	830-001	SCREW- SELF THREAD 8-32X1.7 [2.EA]	49	2256300	TIE WRAP
20	830-076	THRU BOLT 8-32X8.0 [2.EA]	50	2062510	CONTROL BOX ENDURA
21	423-127	HOUSING- PLAIN END PLAST ASSEMBLY INCLUDES 21, 22, 23, 24	51	2060214	CONTROL BOX COVER BLACK
22	144-049	BEARING- FLANGE	52	2065648	DECAL COVER ENDURA PRO 32
23	880-003	**SEAL	53	2064023	SWITCH-FWD/REV 5 SP
24	880-006	**SEAL W/SHIELD	54	2033401	SCREW-10-24X1-3/4 PPH Z/P
25	2069260	MOTOR ASSEMBLY 12V 3.25 5SPC TXT	55	2013110	NUT-10-24 HEX ZCP
26	2032045	TUBE, COMPOSITE 30"	56	2012100	SCREW-8-18X5/8 THD CUT [6.EA]
■	1378121	PROP KIT (includes items 27-30)	57	2990901	HANDLE ASSEMBLY 5 SPEED
27	2061121	PROPELLER- 3.25 DIA HUB	58	2060405	PIVOT, HANDLE
28	2151726	WASHER- 5/16 STD SS	59	2012102	SCREW
29	2053101	NUT- NYLOC 5/16 SS			
30	2092600	PIN-DRIVE			
■	2771818	BRACKET & HINGE ASSY (INCLUDES- 33—45)			
■	2771910	BRACKET ASSEMBLY (INCLUDES- 33,35,36)			
*33	2061910	BRACKET			
34	2060510	PIN-HINGE			
■	2881300	SCREW CLAMP, WASHER, RETAINER KIT [2.EA]			
*35	2061300	SCREW-CLAMP [2.EA]			

****Seal & Oring Kit P/N 2883460**

*This item is part of an assembly. This item cannot be sold separately due to machining and /or assembly that is required.

P/N 2064933 REV.B 12-03

