

70PD/AP  
70 LBS THRUST  
24 VOLT 42 AMPS  
54" OR 60" SHAFT

for use with "AG" serial numbers  
3-year warranty from the date of purchase

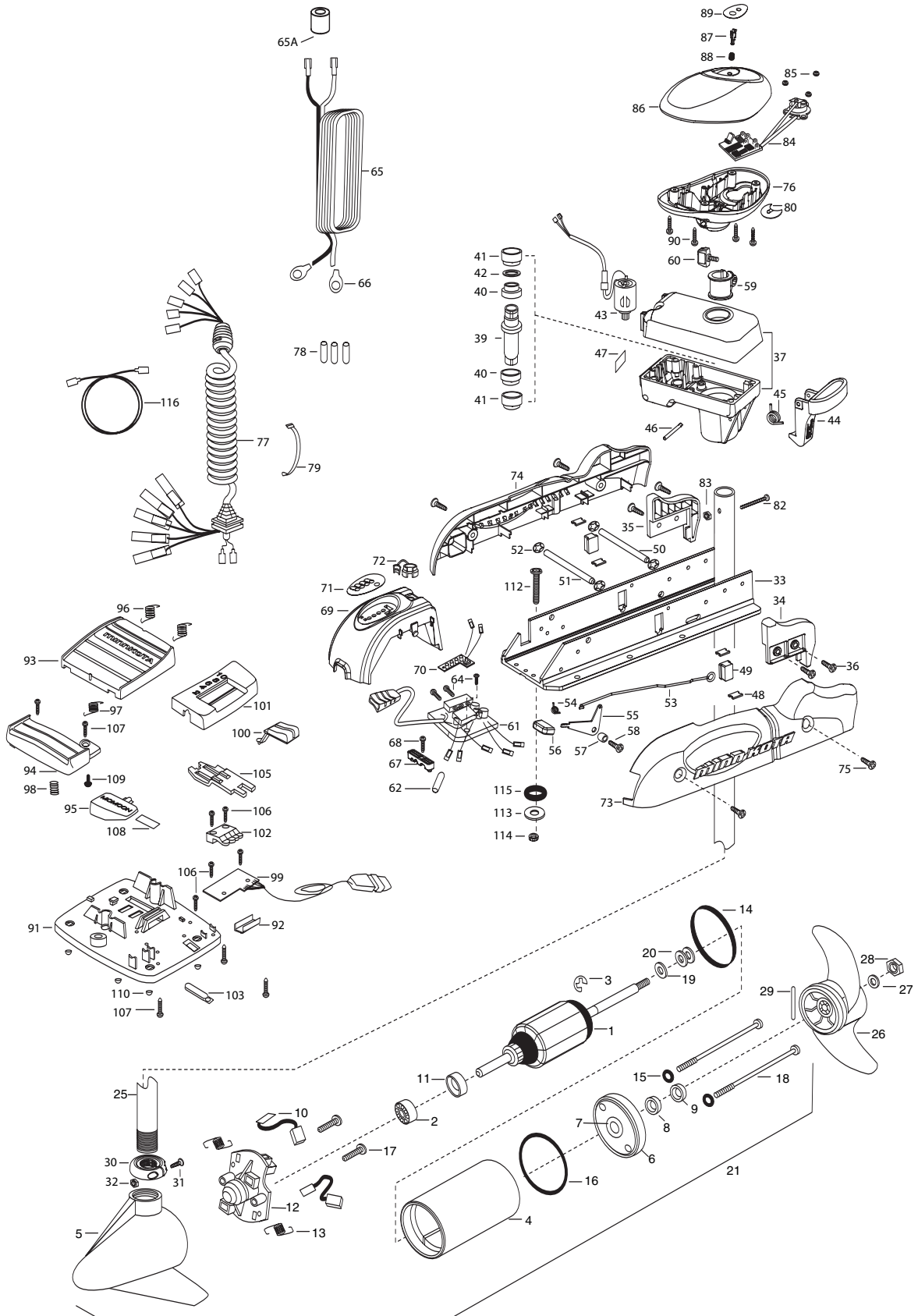

1	2-100-119	ARMATURE ASSEMBLY	*39	2302010	DRIVE HOUSING OUTPUT SHAFT	2991287	COIL CORD WSTRAIN RELEIF 60"
2	140-010	BALL BEARING	*40	2307304	BUSHING- INNER [2.EA]	78	2065400 WIRE INSULATOR-LGE 1-3/4 [3.EA]
3	788-015	RETAINING RING	*41	2307305	BUSHING- OUTER [2.EA]	79	9950433 TIE WRAP-4" BLACK
4	2-200-005	CENTER HOUSING ASSEMBLY	*42	2304603	O-RING	80	2224700 INSERT- PLUG
5	421-065	HOUSING BRUSH END 3.62 TXT	43	2307045	MOTOR- DRIVE HOUSING HIGH SPD	82	2332102 SCREW-10-24 X 1-3/4
	9421-166	HOUSING BRUSH END 3.62 SONAR	44	2307205	LATCH HANDLE PD/AP	83	2333101 NUT-HEX 10-24 NYLOC
6	2-400-101	PLAIN END HOUSING ASSEMBLY	45	2302750	SPRING- LATCH TORSION PD/AP	84	2994014 CNTRL BRD/CMPSS ASSMBLY-AUTOPILOT
7	144-049	BEARING - FLANGE (SERVICE ONLY)	46	2302607	PIN- DRIV-LOK GROOVE ZINC TYPE	85	2302960 GROMMET-COMPASS [3.EA]
8	880-003	**SEAL	47	2305515	DECAL-STOW/DEPLOY	86	2300235 CONTROL BOX COVER
9	880-006	**SEAL WITH SHIELD	48	2305110	PAD-PIVOT SUPT [4.EA]	87	2304082 ACTUATOR- SWITCH ON/OFF A/P
10	188-036	BRUSH ASSEMBLY [2.EA]	49	2305103	PIVOT PAD [2.EA]	88	2302752 SPRING- ACTUATOR PD/AP SS
11	725-050	BRUSH RETENTION- PAPER TUBE	50	2300500	PIN-LATCH	89	2305676 DECAL- COVER 70PD/AP
12	738-036	BRUSH PLATE W/HOLDER	51	2300510	PIN-PIVOT		2305677 DECAL - COVER 70 PD/AP/SONAR
13	975-040	SPRING - TORSION [2.EA]	52	2013100	NUT-SPEED [4.EA]	90	2372100 SCREW-8-18 X 5/8 [4.EA]
14	337-036	**GASKET	53	2303612	ROD-RELEASE RT/AP SS	■	2774700 FOOT PEDAL ASSEMBLY
15	701-008	**O-RING, THRU-BOLT [2.EA]	54	2302700	SPRING-RELEASE LEVER	91	2304511 FOOT PEDAL BASE
16	701-081	**O-RING	55	2303710	LEVER-RELEASE	92	2308500 WEAR PLATE FOOT PDL
17	830-007	SCREW-8-32 [2.EA]	56	2300101	RELEASE-KNOB	93	2304516 FOOT PEDAL-UPPER
18	830-008	THRU-BOLT 10-32X9.2 [2.EA]	57	2301700	SPACER-RELEASE LEVER	94	2304520 FOOT PEDAL-LOWER
19	990-067	WASHER- STEEL THRUST	58	2303430	SCREW-1/4-20 X 5/8	95	2307210 LEVER MOM/CON-
20	990-070	WASHER - NYLATRON	59	2031522	COLLAR- DRIVE (W/INSERT)	96	2302730 SPRING-LONG-UPPER PEDAL [2.EA]
21	2096031	MOTOR ASSEMBLY 24V 3.62 VARS F/W	60	2011365	SCREW-COLLAR/NEW KNOB	97	2302731 SPRING-SHORT-UPPER PEDAL
	2106031	MOTOR ASSEMBLY-SONAR 24V 3.62 VARS F/W	61	2304045	CTRL BOARD ASSEMBLY-24V PD/AP	98	2302732 SPRING-LOWER PEDAL
25	2032076	TUBE- COMPOSITE 54"	62	2355410	SHRINK TUBE-1/2 ODX2	99	2304012 CONTROL BOARD ASSEMBLY-FT PDL
	2032077	TUBE- COMPOSITE 62"	64	2332100	SCREW-8-32 X 3/8 [3.EA]	100	2300120 KNOB-SPEED SELECTOR
■	1378131	PROPELLER KIT	65	2090601	LEADWIRE IOGA 44"	101	2300121 HOUSING SPEED SELECTOR
26	2091160	PROPELLER W/WEDGE 2	65A	2307310	BEAD - FERRITE [2 EA] (CE MODELS ONLY)	102	2302840 ACTUATOR-BOARD
27	2151726	WASHER-5/16 SS	66	2020700	TERMINAL RING [2.EA]	103	2302841 ACTUATOR-MOM/CON
28	2053101	NUT-PROP NYLOC	67	2222906	STRAIN RELIEF- BRACKET PD/AP	105	2302842 ACTUATOR-STEERING
29	2092600	PIN-DRIVE	68	2303430	SCREW-1/4-20 X 5/8	106	2302100 SCREW-6-20 X 1/2 [5.EA]
30	2301545	COLLAR- LATCH PD/AP	69	2306555	HOUSING- CENTER PD/AP	107	2372100 SCREW-8-18 X 5/8 [5.EA]
31	2303434	SCREW- 8-32X5/8 MACH PHCR	70	2034026	BATTERY GAUGE - 24 VOLT	108	2266610 DECAL-ON/OFF SWITCH
32	2303112	NUT 8-32 NYLOC SS	71	2306609	DECAL, BATTERY GAUGE	109	2335130 BUMPER ACTUATOR
33	2301932	EXTRUSION- BASE MACHINED	72	2302935	STRAIN RELIEF-DR. HOUSING	110	2994807 BAG ASSEMBLY- 4 RUBBER BUMPERS
34	2303932	MOTOR REST- RIGHT LARGE	73	2303941	SIDEPLATE (RIGHT)	■	2994803 BAG ASSEMBLY- (BOLT,NUT,WASHERS)
35	2303937	MOTOR REST- LEFT LARGE	74	2303946	SIDEPLATE(LEFT)	*112	2153501 BOLT-MOUNTING-3500 W/STG [4.EA]
36	2303430	SCREW 1/4-20X5/8 SELF TAP [4.EA]	75	2303430	SCREW-1/4-20 X 5/8- [4.EA]	*113	2151726 WASHER-5/16 [4.EA]
37	2301845	DRIVE HOUSING PD/AP 2001	76	2772515	CONTROL BOX / DECAL ASSEMBLY	*114	2153100 NUT-5/16-18 MOUNTING [4.EA]
■	2882011	BUSHING/ OUTSHAFT KIT (INCLUDES 39-42)	77	2991285	COIL CORD WSTRAIN RELEIF 54"	*115	2301720 WASHER-MOUNTING RUBBER [6.EA]
						116	2211405 EXTENSION CABLE- SONAR

\*\* Seal & Oring Kit P/N 2888460 \* This item is part of an assembly. This item cannot be sold separately due to machining and /or assembly that is required.

P/N 2304918

REV.C 7-05

