

RT55/SC/B
55 LBS THRUST
12 VOLT 50 AMPS
42" & 52" SHAFT

for use with "AG" serial numbers
3-year warranty from the date of purchase

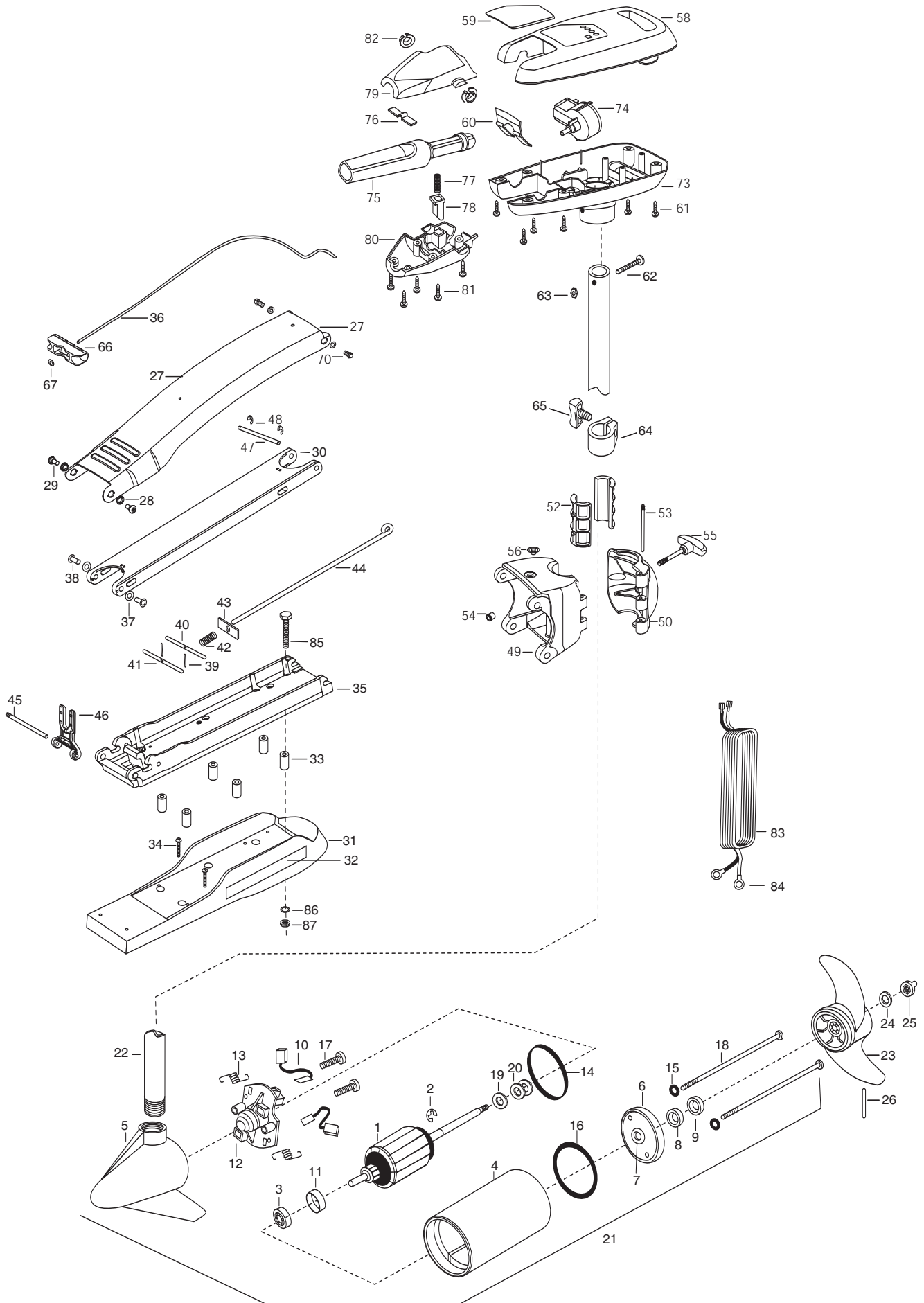

1	2-100-115	ARMATURE ASSEMBLY 12V 3.625 55#	31	2263914	MOTOR REST STD MAXXUM WHT	66	2150400	PULL-GRIP (RAW)
2	788-015	RETAINING RING	32	2065676	DECAL- MOTOR REST RT-W [2. EA]	67	2151700	WASHER-EYE SHAFT(.562 OD)
3	140-010	BEARING -BALL	33	2261505	SPACER, MOTOR REST [6.EA]	70	2263500	BOLT, SHOULDER [2. EA]
4	431-301	CENTER HOUSING ASSEMBLY 3.62 SW TXT WHT	34	2263434	SCREW, 8-18 X 1 PPH SS [2.EA]	73	2062552	CONTROL BOX PLAS W/HAND 5SP W
5	2-300-337	BRUSH END HOUSING ASSEMBLY 3.62 SPCO	35	2993983	BOWPLATE/INSERT	74	2064023	SWITCH-FWD/REV 5SP W
6	2-400-337	PLAIN END HOUSING ASSEMBLY 3.62	36	2251601	ROPE (40"), MAXXUM MOUNT	75	2990911	HANDLE ASSEMBLY-W/U-JOINT 5SP W
7	144-049	BEARING - FLANGE [SERVICE ONLY]	37	2261708	WASHER-3/8 X1/2X.010 SS [2.EA]	76	2302742	SPRING-DETENT (OFF) SS
8	880-003	**SEAL	38	2236000	BEARING NYLINER- [2.EA]	77	2302745	SPRING-RELEASE BUTTON SS
9	880-006	**SEAL WITH SHIELD	39	2152610	SPRING-PIN (LOCKBAR)	78	2303720	RELEASE BUTTON-HANDLE
10	188-036	BRUSH ASSEMBLY [2. EA]	40	2233601	LOCKBAR SS (NEW 500)	79	2060410	HANDLE (TOP HALF)
11	725-050	PAPER TUBE- BRUSH RETENTION	41	2233603	LOCK BAR, REAR - SS	80	2060415	HANDLE (LOWER HALF)
12	738-036	BRUSH PLATE W/HOLDER	42	2152701	SPRING-(LOCKBAR) SS [2.EA]	81	2303412	SCREW-6-20 X 5/8 SELF TAP [5.EA]
13	975-040	SPRING - TORSION [2. EA]	43	2262703	SPRING STOP	82	2060005	BEARING-HANDLE PIVOT [2.EA]
14	337-036	**GASKET	44	2153603	EYE SHAFT-2LOCKEAR STD	83	2090650	LEADWIRE (10 GA) RINGS
15	701-008	**O-RING [2. EA]	45	2260505	PIN-HINGE (HEADLE5S) SS	84	2020700	TERMINAL RING, 3/8 [2.EA]
16	701-081	**O-RING	46	2293811	YOKE,MAX MNT-POLYPROPYLE	■	2994830	BAG ASSEMBLY-MAXXUM
17	830-007	SCREW # 8-32 [2.EA]	47	2260512	HINGE PIN (MAX,A/T) S/S	85	2263431	SCREW 1/4-20 X 3.5 PPH [6.EA]
18	830-042	THRU BOLT 10-32 X 8.83 [2. EA]	48	2263011	E-RING 3/8 DIA. SHAFT [2. EA]	86	2261713	WASHER-1/4 FLAT S/S [6.EA]
19	990-067	WASHER - STEEL THRUST	49	2991863	HINGE BASE/INSERT ASSEMBLY,SW,	87	2263103	NUT-1/4-20 NYLOCK-JAM SS [6.EA]
20	990-070	WASHER - NYLATRON [2. EA]	50	2261859	HINGE DOOR STD WHT TEX			
21	2097097	MOTOR ASSEMBLY 12V 3.625 SW 5SPC 55-W	52	2151532	HINGE-SLEEVE HALF-AT [2. EA]			
22	2032033	TUBE (COMPOSITE) 42" BM W	53	2262642	PIN-HINGE DOOR, RT HNG,			
	2032034	TUBE (COMPOSITE) 52" BM W	54	2264706	INSERT-HINGE BASE (STD MT)			
■	1378131	PROPELLER KIT	55	2260186	KNOB-HINGE COVER SW S/S			
23	2091160	PROPELLER- WEEDLESS WEDGE 2	56	2232315	EYELET-ROPE STAINLESS STEEL			
24	2151726	WASHER- 5/16 STD SS	58	2060264	COVER-CTRL BOX RT WHITE			
25	2198400	ANODE- ZINC 3.25/3.62 LWR U	59	2195648	DECAL-COVER RT55/SC HC WHT			
26	2092600	PIN-DRIVE SS	60	2302743	SPRING-DETENT (HANDLE-TILT)			
■	2991845	MOUNT, BOW ASSEMBLY, SW STD W	61	2303412	SCREW-6-20 X 5/8 SELF TAP [6.EA]			
27	2264244	ARM-UPPER SW TXT WH	62	2332102	SCREW-10-24 X 1-3/4 SS			
28	2293501	BUSHING, STAINLESS STEEL [4.EA]	63	2333101	NUT-HEX SS NYLOC			
29	2263500	BOLT, SHOULDER (MAXXUM) [4.EA]	64	2031520	COLLAR-DEPTH (W/O INSERT)			
30	2994310	ARM-LOWER ASSEMBLY,STD,SW,EX/M	65	2011366	SCREW-COLLAR/NEW KNOB SS			

** Seal & Oring Kit P/N 2888460 * This item is part of an assembly. This item cannot be sold separately due to machining and /or assembly that is required.

p/n 2074955 REV.A 7-04

