

ENDURA 50
50 LBS. THRUST
12 VOLT 42 AMPS
36" OR 42" SHAFT

for use with "AI" serial numbers
3-year warranty from the date of purchase

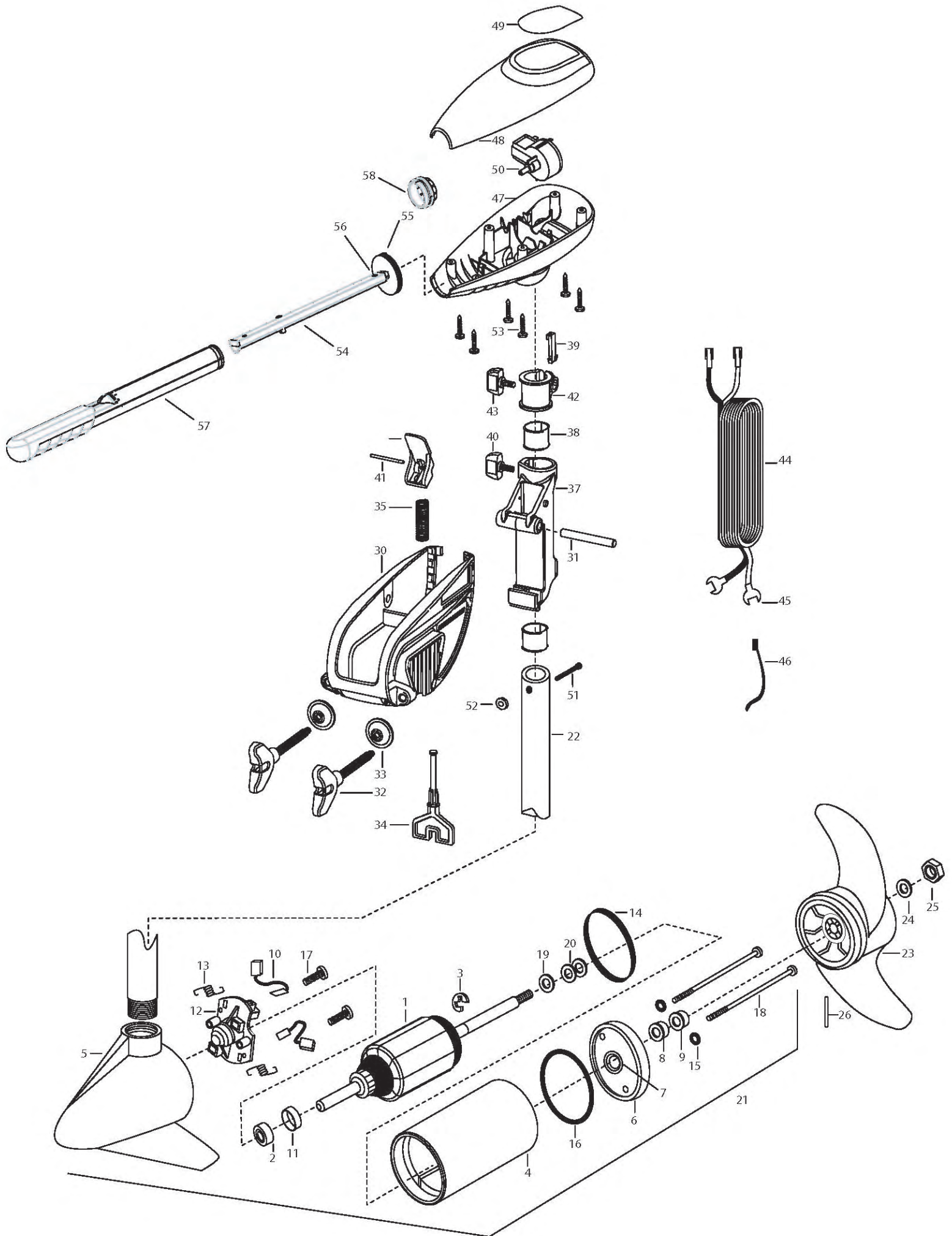

1	2-100-118	ARMATURE ASSEMBLY 12V 3.62 FW	■	2881300	SCREW-CLAMP, WASHER, RETAINER KIT [2.EA]
2	140-010	BEARING- BALL	*32	2061300	SCREW-CLAMP [2.EA]
3	788-015	RETAINING RING	*33	2011710	WASHER-CLAMP SCREW [2.EA]
4	2-200-101	CENTER HOUSING ASSEMBLY-	34	2063605	T-BAR, PLASTIC
5	2-300-196	BRUSH END HOUSING ASSEMBLY 3.62 SPCO 36"	35	2062706	SPRING- T-BAR
	2-300-195	BRUSH END HOUSING ASSEMBLY 3.62 SPCO 42"	36	2067201	LEVER-TILT BLACK
6	2-400-101	PLAIN END HOUSING ASSEMBLY	37	2061810	HINGE-PLASTIC
7	144-049	BEARING- FLANGE ,SERVICE ONLY	38	2037301	BUSHING-HINGE [2.EA]
8	880-003	SEAL	39	2062800	TENSION BLOCK-SNAP IN
9	880-006	SEAL WITH SHIELD	40	2011385	SCREW, TENSION/KNOB
10	188-036	BRUSH ASSEMBLY [2.EA]	41	2060515	PIN, TILT LEVER
11	725-050	BRUSH RETENTION- PAPER TUBE	42	2061520	COLLAR-DEPTH
12	738-036	BRUSH PLATE WITH HOLDER	43	2011365	SCREW-COLLAR/NEW KNOB
13	975-040	SPRING- TORSION [2.EA]	44	2050609	LEADWIRE 10 GA SPADE TERM
14	337-036	GASKET	45	2020702	SPADE TERMINAL 10GA. [2.EA]
15	701-008	O-RING [2.EA]	46	2026300	TIE WRAP [2.EA]
16	701-081	O-RING	47	2062510	CONTROL BOX
17	830-007	SCREW- # 8-32 [2.EA]	48	2060214	CONTROL BOX COVER-ENDURA
18	830-042	THRU BOLT 10-32X8.83 [2EA]	49	2065642	DECAL COVER ENDURA 50
19	990-067	WASHER- STEEL THRUST	50	2064023	SWITCH-FWD/REV 5 SP
20	990-070	WASHER- NYLATRON [2.EA]	51	2033400	SCREW-10-24 X 1-3/4
21	2097061	MOTOR ASSEMBLY 12V 3.62 5SPC FW 36"	52	2013110	NUT-10-24 HEX
	2097062	MOTOR ASSEMBLY 12V 3.62 5SPC FW 42"	53	2012100	SCREW-8-18 X 5/8 [6.EA]
22	2032052	TUBE COMPOSITE 36"	54	2990919	INNER HANDLE ASSEMBLY
	2032053	TUBE COMPOSITE 42"	55	2060405	PIVOT, HANDLE
■	1378131	PROPELLER- KIT	56	2012102	SCREW
23	2091160	PROP- W. WEDGE 2	57	2990929	OUTER HANDLE ASSEMBLY
24	2151726	WASHER- 5/16 STD SS	58	2060009	FRONT BEARING
25	2053101	NUT- NYLOC 5/16	■	2888460	O-RING, GASKET SEAL KIT
26	2092600	PIN-DRIVE			
■	2771818	BRACKET & HINGE ASSEMBLY (INCLUDES- 30—41)			
■	2771910	BRACKET ASSEMBLY (INCLUDES- 30,32,33)			
*30	2061910	BRACKET			
31	2060510	PIN-HINGE			

* This item is part of an assembly. This item cannot be sold separately due to machining and /or assembly that is required.

P/N 2064949

REV. D 11-06

