

70 PD/AP  
70 LBS THRUST  
24 VOLT 42 AMPS  
54" , OR 60" SHAFT

For use with "J" serial numbers  
3-year warranty from the date of sale

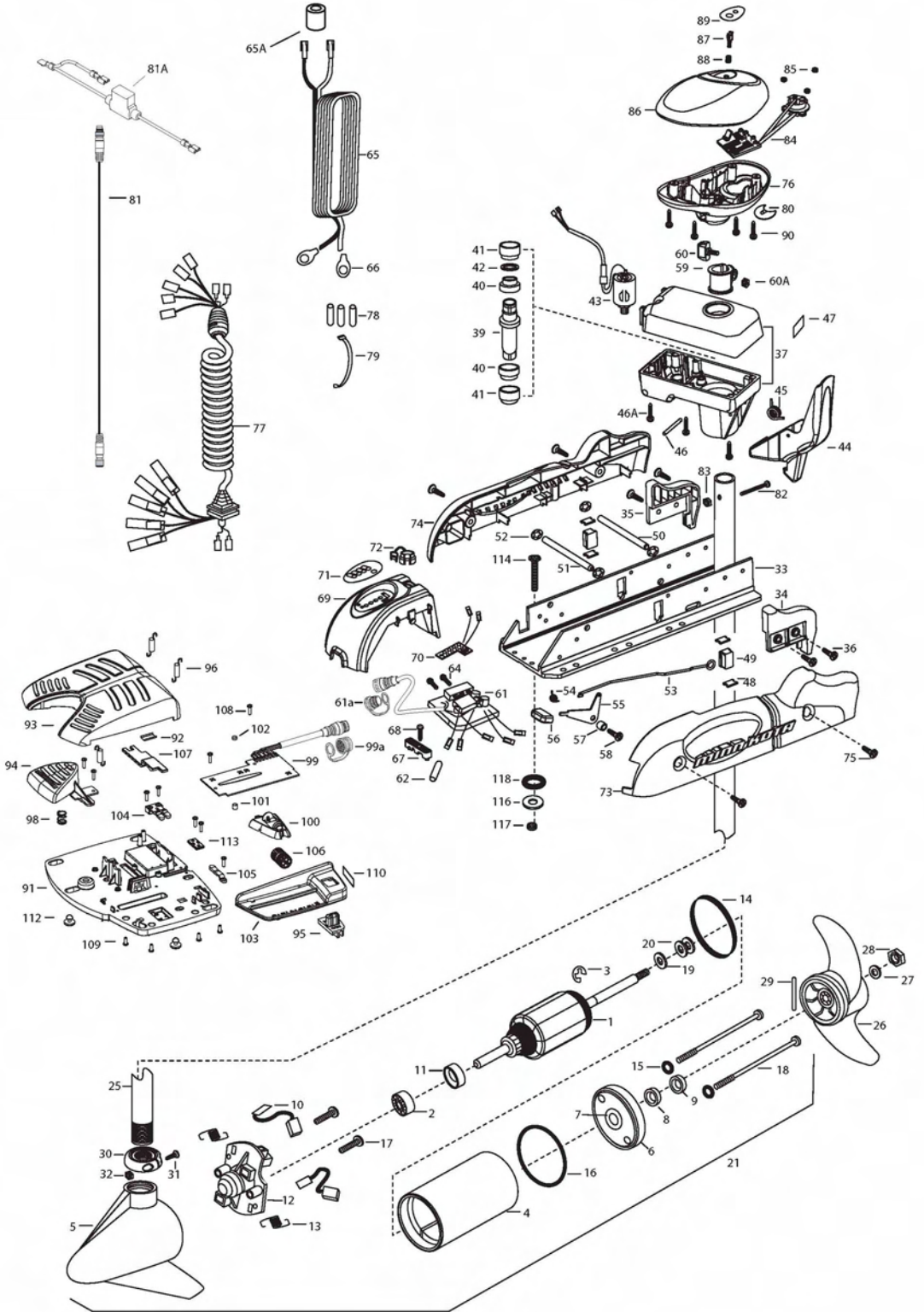

1	2-100-119	ARMATURE ASSEMBLY 24V VARS TXT	*41	2307305	BUSHING- OUTER [2.EA]	80	2224702	INSERT- PLUG
2	140-010	BALL BEARING	*42	2304603	O-RING		2224700	INSERT- PLUG US2
3	788-015	RETAINING RING	43	2307050	MOTOR- DRIVE HOUSING HIGH SPD	81	2211415	UNIVERSAL SONAR II EXTENSION CABLE
4	2-200-005	HOUSING ASSEMBLY CENTER 3.62 TXT	44	2307201	LATCH HANDLE PD/AP	81A	2218200	FUSE HOLDER, US2 MOTORS ONLY
5	421-065	HOUSING -BRUSH END 3.62 TXT	45	2302750	SPRING- LATCH TORSION PD/AP	82	2033400	SCREW-10-24 X 1-3/4 PPH Z/P
	9421-168	HOUSING BRUSH END 3.62 SONAR 54"/60"	46	2302627	PIN- ROLL ZINC	83	2013110	NUT-HEX 10-24 ZCP
6	2-400-101	PLAIN END HOUSING ASSEMBLY 3.625	46A	2303407	SCREW - DRIVE HOUSING [6 EA]	84	2994014	CNTRL BRD/CMPSS ASSMBLY-AP
7	144-049	BEARING - FLANGE (SERVICE ONLY)	47	2305564	DECAL-STOW/DEPLOY	85	2302960	GROMMET-COMPASS [3.EA]
8	880-003	SEAL	48	2305110	PAD-PIVOT SUPT [4.EA]	86	2300237	CONTROL BOX COVER
9	880-006	SEAL WITH SHIELD	49	2305103	PIVOT PAD- NEW MTR'L [2.EA]	87	2304082	ACTUATOR- SWITCH ON/OFF A/P
10	188-037	BRUSH ASSEMBLY [2.EA]	50	2300500	PIN-LATCH	88	2302752	SPRING-ACTUATOR PD/AP SS
11	725-035	BRUSH RETENTION- PAPER TUBE	51	2300510	PIN-PIVOT	89	2305653	DECAL- COVER 70 PD/ AP
12	738-036	BRUSH PLATE W/HOLDER	52	2013100	NUT-SPEED [4.EA]		2305654	DECAL - COVER 70 PD / AP / US
13	975-040	SPRING - TORSION [2.EA]	53	2303612	ROD-RELEASE RT/AP S	90	2372100	SCREW-8-18 X 5/8 THD CUT [4.EA]
14	337-036	GASKET	54	2322700	SPRING-RELEASE LEVER	■	2994725	FOOT PEDAL ASSEMBLY
15	701-008	O-RING, THRU-BOLT [2.EA]	55	2303710	LEVER-RELEASE	91	2304505	FOOT PEDAL BASE
16	701-081	O-RING	56	2300101	RELEASE-KNOB	92	2308501	WEAR PLATE FOOT PDL
17	830-007	SCREW-8-32 [2.EA]	57	2301700	SPACER-RELEASE LEVER	93	2300255	FOOT PEDAL, CORDED UPPER
18	830-008	THRU-BOLT 10-32X9.2 [2.EA]	58	2303430	SCREW-1/4-20 X 5/8	94	2303723	BUTTON, MOMENTARY
19	990-067	WASHER- STEEL THRUST	59	2031522	COLLAR- DRIVE (W/INSERT)	95	2303722	BUTTON, MOM/CON
20	990-070	WASHER - NYLATRON [2.EA]	60	2011365	SCREW-COLLAR/NEW KNOB	96	2302730	SPRING-LONG-UPPER PEDAL [3.EA]
21	2096031	MOTOR ASSEMBLY 24V 3.62 54"	60A	2323104	NUT	98	2302732	SPRING-LOWER PEDAL
	2096032	MOTOR ASSEMBLY 24V 3.62 60"	61	2304058	CONTROL BOARD ASSEMBLY- 24V PD/AP	99	2304052	CONTROL BOARD ASSEMBLY-FT PDL
	2106035	MOTOR ASSEMBLY US2 24V 3.62 54"	61A	2320208	DUST PLUG	99A	2320207	DUST CAP
	2106036	MOTOR ASSEMBLY US2 24V 3.62 60"	62	2355410	SHRINK TUBE-3/8 ODX2	100	2308620	SLIDER, SPEED
25	2032076	TUBE-CARBON COMPOSITE 54"	64	2303434	SCREW-8-32 X 5/8 [3.EA]	101	2308409	MAGNET, 1/4 X 1/4
	2032074	TUBE-CARBON COMPOSITE 60"	65	2090651	LEADWIRE IOGA 44"	102	2778408	MAGNET, 1/4 X 1/8
■	1378131	PROPELLER KIT	65A	2307310	BEAD - FERRITE (CE MODELS ONLY)	103	2300252	COVER, SPEED SELECTOR
26	2091160	PROPELLER W/WEDGE 2	66	2020700	TERMINAL RING [2.EA]	104	2308606	SWITCH, DOUBLE FINGER
27	2151726	WASHER-5/16 SS	67	2321310	STRAIN RELIEF- BRACKET PD/AP	105	2308608	SWITCH, SINGLE FINGER
28	2053101	NUT-PROP NYLOC	68	2323405	SCREW-1/4-20 X 5/8	106	2307900	WHEEL, SPEED
29	2092600	PIN-DRIVE	69	2306555	HOUSING- CENTER PD/AP	107	2308625	SLIDER, STEERING
30	2301545	COLLAR- LATCH PD/AP	70	2074071	BATTERY GAUGE - 24 VOLT	108	2302100	SCREW-6-20 X 1/2 [9.EA]
31	2303434	SCREW- 8-32X5/8 MACH PHCR	71	2316605	DECAL, BATTERY GAUGE	109	2372103	SCREW-6.20 X 3/8 [4.EA]
32	2303112	NUT 8-32 NYLOC SS	72	2302935	STRAIN RELIEF-DR. HOUSING	110	2316600	DECAL, ON/OFF SWITCH
33	2301934	EXTRUSION- BASE MACHINED	73	2303960	SIDEPLATE (RIGHT)PD MK	112	2994859	BAG ASSEMBLY- 5 RUBBER BUMPERS
34	2303932	MOTOR REST- RIGHT 3-5/8	74	2303965	SIDEPLATE(LEFT)PD MK	113	2302907	STRN RLF PD FP
35	2303937	MOTOR REST- LEFT 3-5/8	75	2303430	SCREW-1/4-20 X 5/8- [4.EA]	■	2994864	BAG ASSEMBLY- (BOLT,NUT,WASHERS)
36	2303430	SCREW 1/4-20X5/8 SELF TAP [4.EA]	76	2302515	CONTROL BOX PD/AP	*114	2263462	BOLT-MOUNTING-1/4X2 W/STG [6.EA]
37	2771826	DRIVE HOUSING PD V2	77	2991285	COIL CORD WSTRAIN RELIEF 48, 54"	*116	2261713	WASHER-1/4 [6.EA]
■	2882011	BUSHING/ OUTSHAFT KIT (INCLUDES 39-42)		2991287	COIL CORD WSTRAIN RELIEF 60"	*117	2263103	NUT NYLOK 1/4-20 MTG [6.EA]
*39	2302010	DRIVE HOUSING OUTPUT SHAFT	78	2065400	WIRE INSULATOR-LGE 1-3/4 [3.EA]	*118	2301720	WASHER-MOUNTING RUBBER [6.EA]
*40	2307304	BUSHING- INNER [2.EA]	79	2256300	TIE WRAP-5" BLACK	■	2888460	SEAL & ORING KIT

\* This item is part of an assembly. This item cannot be sold separately due to machining and /or assembly that is required.

P/N 2314958

REV. N

ECN 31442

4-09

# 70AP is 24-volt only!

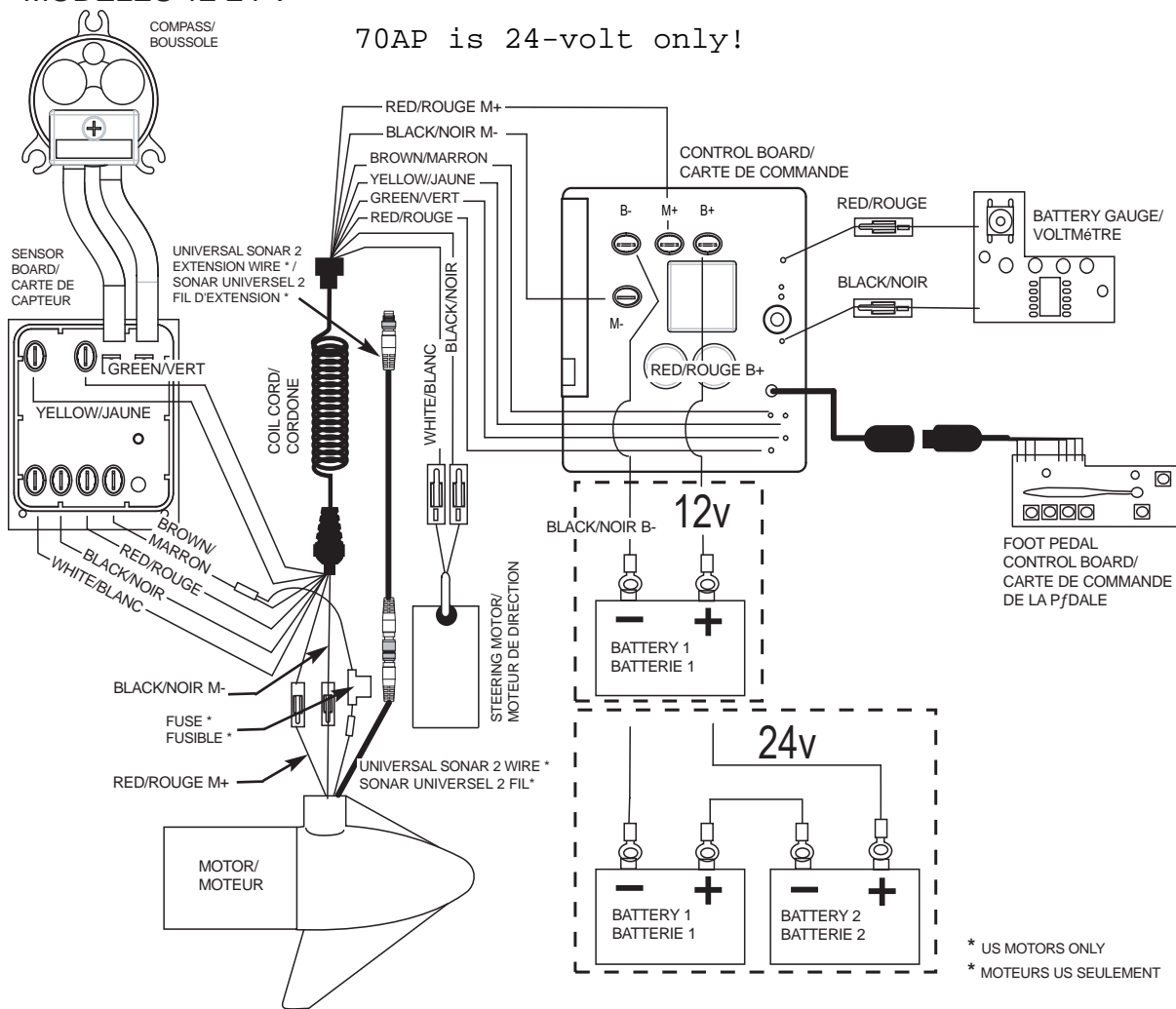

\* US MOTORS ONLY  
\* MOTEURS US SEULEMENT