

ENDURA 40
40 LBS THRUST
12 VOLT 42 AMPS
36" SHAFT

for use with "K" serial numbers
2-year warranty from the date of purchase

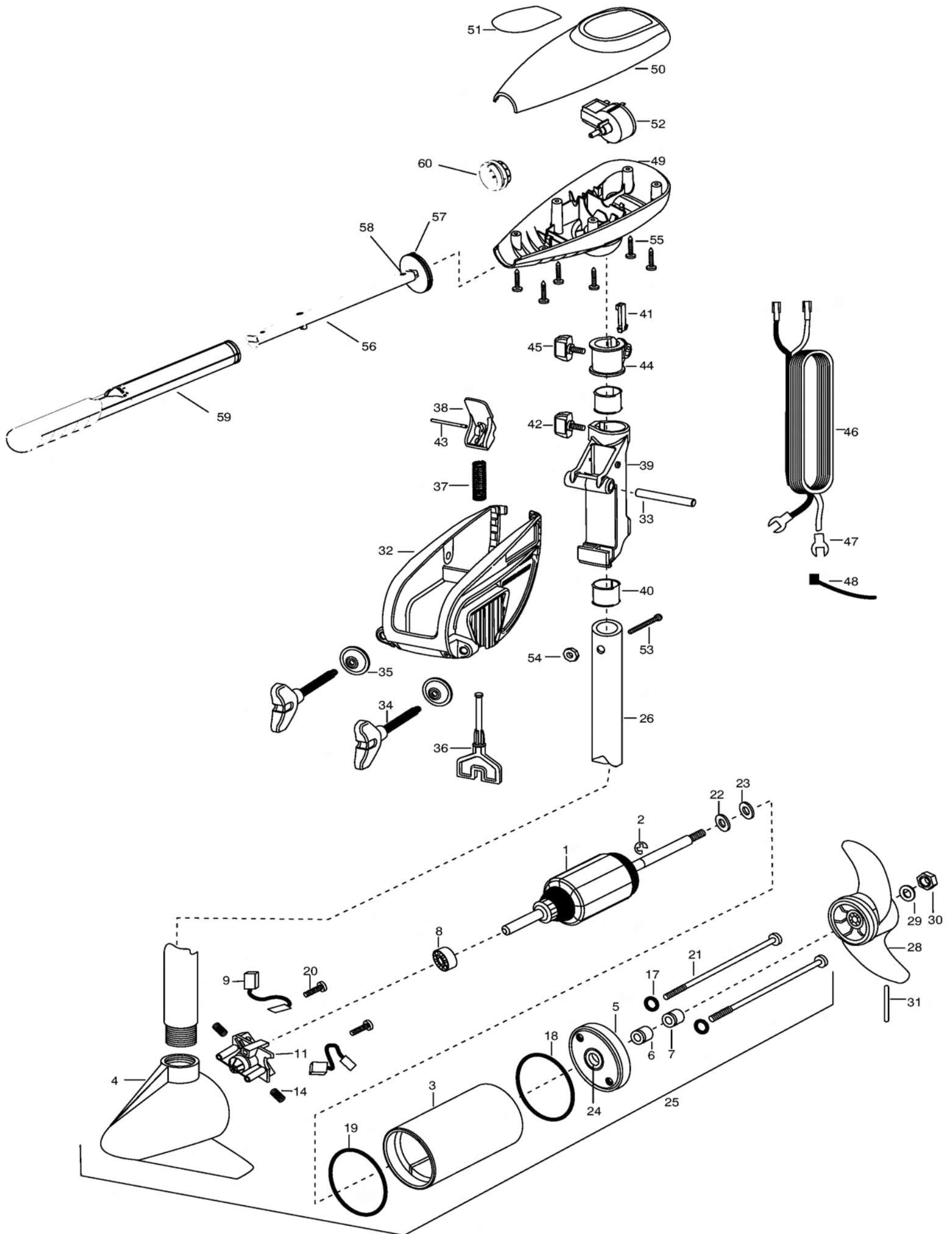

1	2-100-278	ARMATURE ASSEMBLY 12v 3.25	■	2771818	BRACKET & HINGE ASSEMBLY (INCLUDES- 32—43)	56	2990919	INNER HANDLE ASSEMBLY
2	788-015	RETAINING RING	■	2771910	BRACKET ASSEMBLY (INCLUDES- 32,34,35)	57	2060405	PIVOT, HANDLE
3	2-200-079	HOUSING ASSEMBLY CENTER 3.25 TXT	*32	2061910	BRACKET	58	2012102	SCREW
4	2-300-132	BRUSH END HOUSING ASSEMBLY 3.25 SP.CO	33	2060510	PIN-HINGE	59	2990929	OUTER HANDLE ASSEMBLY
5	2-400-187	PLAIN END HOUSING ASSEMBLY 3.25	*34	2061300	SCREW-CLAMP [2.EA]	60	2060009	FRONT BEARING
6	880-003	SEAL	*35	2011710	WASHER-CLAMP SCREW [2.EA]	■	2883460	SEAL AND O RING KIT
7	880-006	SEAL W/SHIELD	36	2063605	T-BAR, PLASTIC			
8	140-010	BALL BEARING	37	2062706	SPRING- (T-BAR)			
9	188-052	BRUSH ASSEMBLY [2.EA]	38	2067201	LEVER-TILT BLACK			
11	738-030	BRUSH PLATE W/HOLDER 3.25	39	2061810	HINGE-PLASTIC			
14	975-032	SPRING- COMPRESSION [2.EA]	40	2037301	BUSHING-HINGE [2.EA]			
17	701-007	O-RING- THRU BOLT [2.EA]	41	2062800	TENSION BLOCK-SNAP IN			
18	701-039	O-RING MK406460	42	2011385	SCREW, TENSION/KNOB			
19	701-041	O-RING	43	2060515	PIN, TILT LEVER			
20	830-001	SCREW- SELF THREAD 8-32X1.7 [2.EA]	44	2061520	COLLAR-DEPTH			
21	830-078	THRU BOLT 8-32X8.0 [2.EA]	45	2011365	SCREW-COLLAR/NEW KNOB			
22	990-067	WASHER- STEEL THRUST	46	2050609	LEADWIRE (10 GA) W/SPADE TERM			
23	990-070	WASHER- NYLATRON [2.EA]	47	2020703	SPADE TERMINAL 14GA HD [2.EA]			
24	144-049	FLANGE BEARING (SERVICE ONLY)	48	2026300	TIE WRAP			
25	2069241	MOTOR ASSEMBLY 12V 3.25 5SPC TXT	49	2062510	CONTROL BOX			
26	2032046	TUBE, COMPOSITE 36"	50	2060214	CONTROL BOX COVER			
■	1378121	PROP W/DRIVE PIN, WASHER, NUT KIT	51	2065640	DECAL COVER ENDURA 40			
28	2061122	PROPELLER 3.25 HUB DIA	52	2064023	SWITCH-FWD/REV 5 SP			
29	2151726	WASHER- 5/16 STD SS	53	2033401	SCREW-10-24 X 1-3/4			
30	2053101	NUT-PROP NYLOCK (MED) SS	54	2013110	NUT-10-24 HEX			
31	2092600	PIN-DRIVE	55	2012100	SCREW-8-18 X 5/8 [6.EA]			

* This item is part of an assembly. This item cannot be sold separately due to machining and /or assembly that is required.

